

ALU TRACK LIFT

2.35

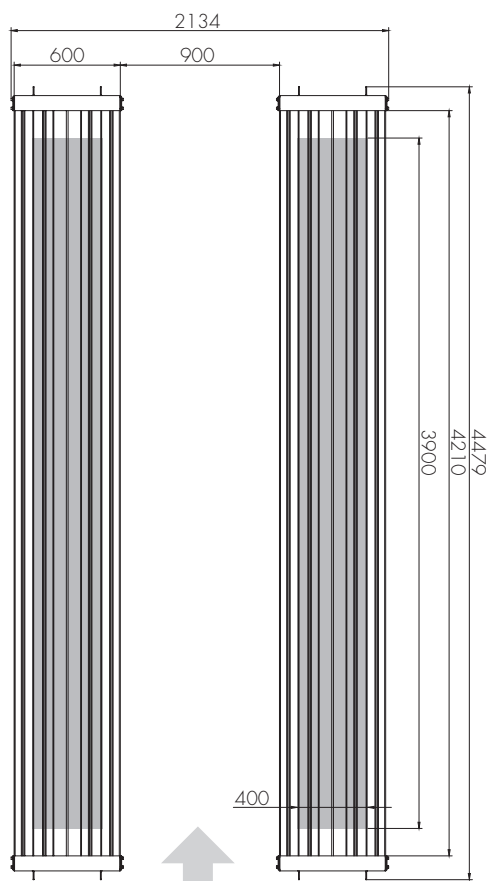
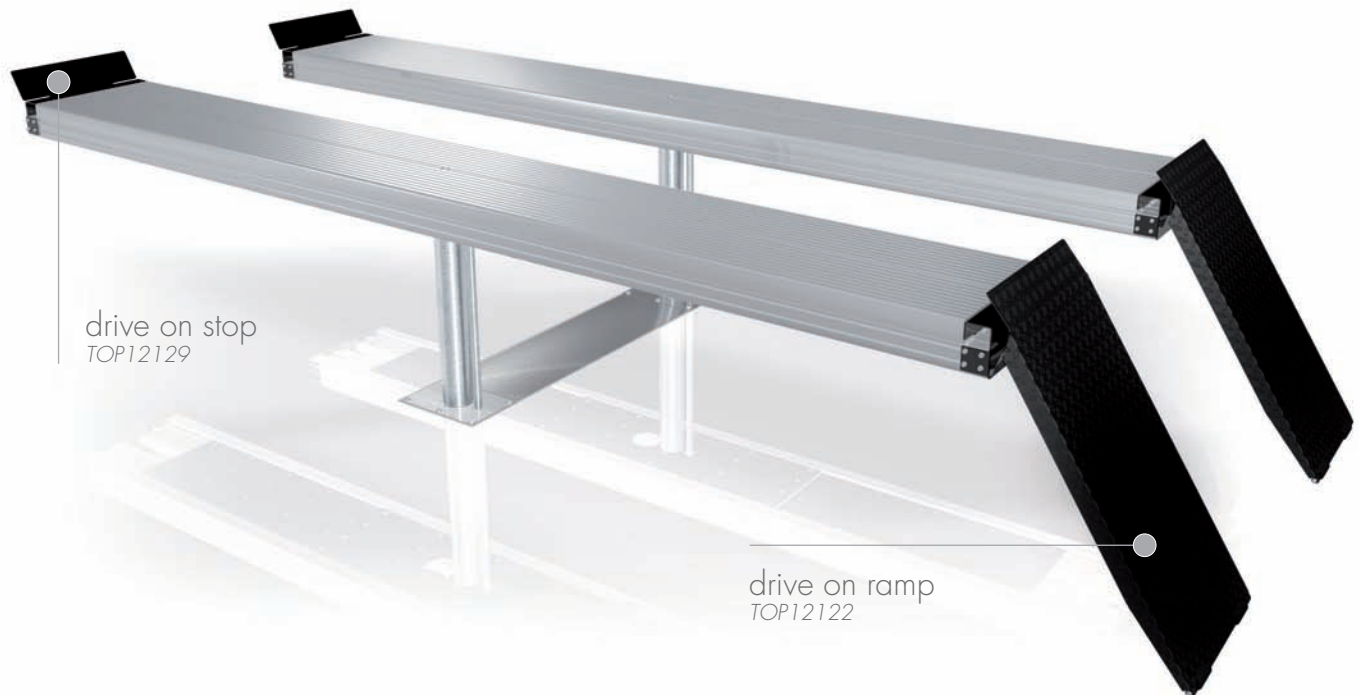

TECHNICAL DATA

load capacity	3500 kg
lifting height	1860 mm
effective raise height	2020 mm
platform length	4400 mm
platform height	175 mm
piston diameter	123 mm
piston distance	1500 mm
installation depth	2443 mm
motor output	3,0 kW
power connector	400 V/16 A
cable length to control	8 m
lifting time	40 sec.
lowering time	40 sec.

pre-assembled with cassette	TOP10038
cassette	TOP11036
without cassette (delivery in wooden case)	TOP10138
basic unit (incl. cassette without support)	TOP20118
support	TOP20901

ACCESSORIES

PLATFORM ALU TRACK

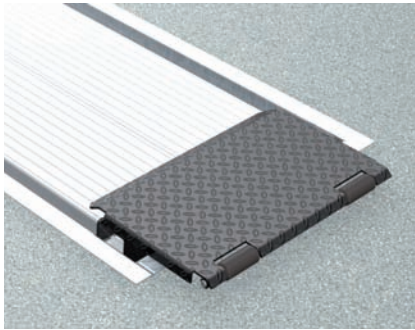

drive on ramp

for installation flush with floor level
TOP12121

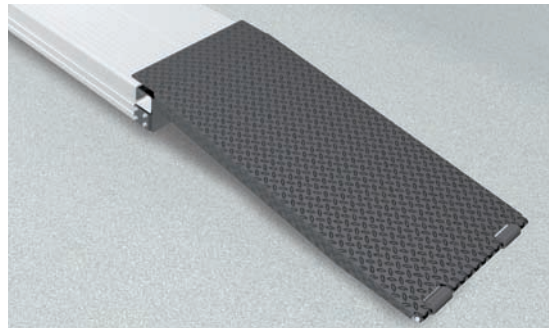

drive on ramp

for floor incumbent installation
1250 mm, hanging, bevel 7°
TOP12122

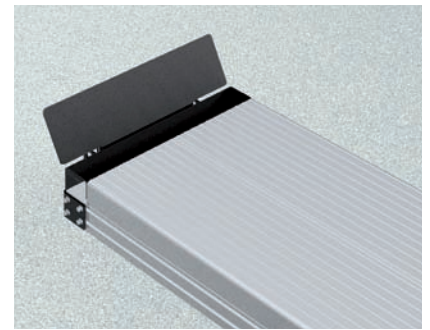

drive on stop

TOP12129

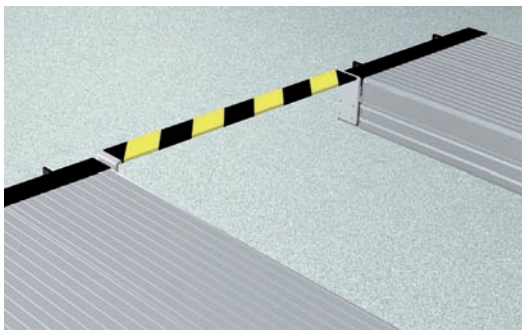

roll bar

for install. flush with floor level
TOP12138

floor incumbent installation
TOP12106

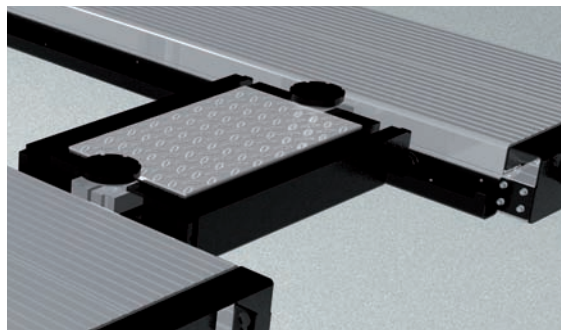

axle lifter

2000 kg, pneumatic, incl. slide rails
TOP12149

2500 kg, pneumatic, incl. slide rails
TOP12150



slide rail set

incl. fastening material
TOP12151



wheel alignment support

1350 mm 600 mm
TOP12152 TOP12153

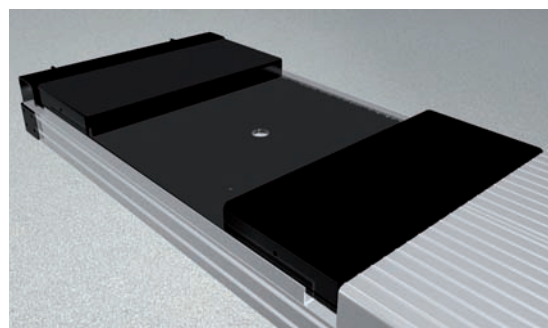

platform notches for turn table

incl. levelling plates and compensating pieces,
notches height adjustable
TOP12191

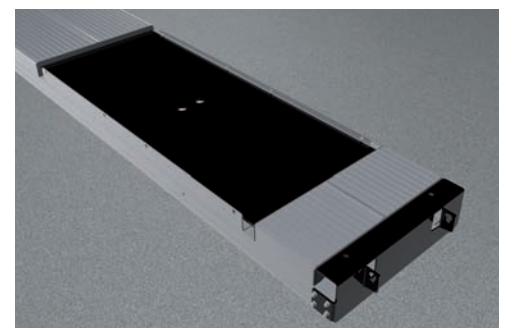

platform notches for sliding plate

TOP12192

ACCESSORIES

PLATFORM ALU TRACK

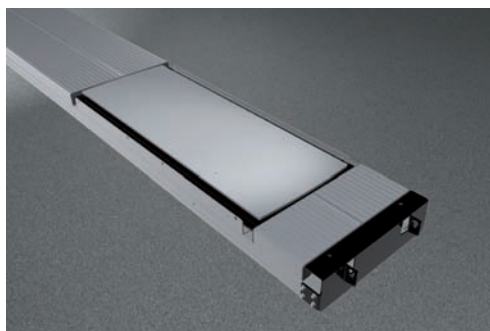

sliding plate
standard

TOP12196

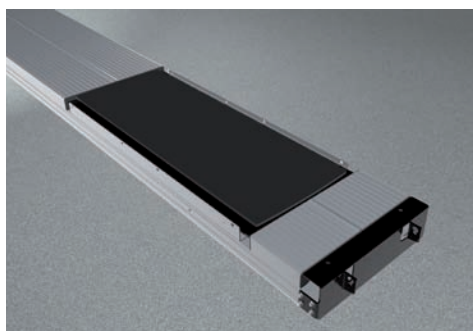

sliding plate
precision

TOP12193

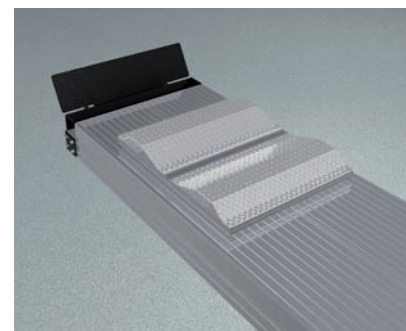

joint play tester

incl. remote control
TOP12136V2



illumination set LED

Alu Track
TOP12167

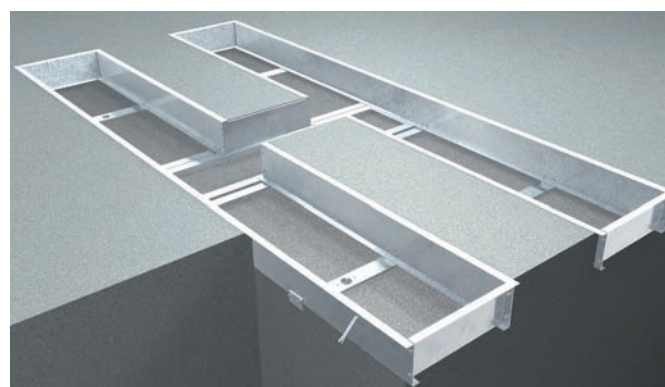

surround frame

4400 mm galvanized, for install. flush with floor level
TOP12139

4800 mm galvanized, for install. flush with floor level
TOP12140

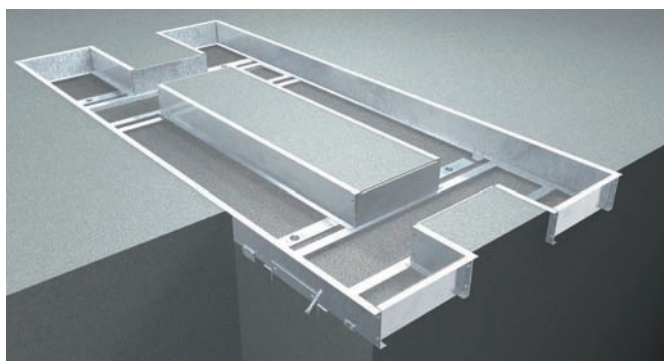

surround frame

4800 mm galvanized, for install. flush with floor level
TOP12160

5500 mm galvanized, for install. flush with floor level
TOP12161

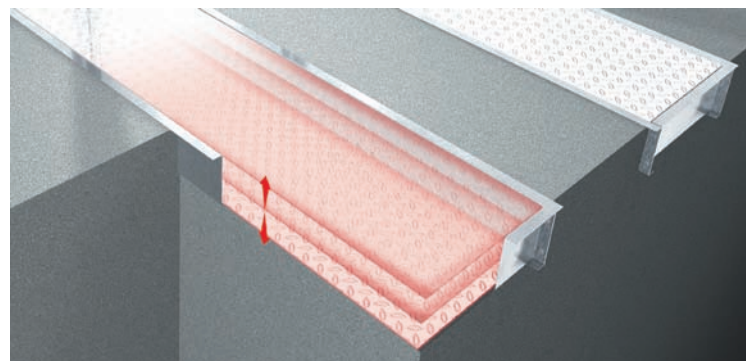

automatic floor levelling system

2-pi. 4400 mm 2-pi. DUPLO 4400 mm 4-pi. 4800 mm
TOP12143 TOP12141 TOP12162

2-pi. 4800 mm 2-pi. DUPLO 4800 mm 4-pi. 5500 mm
TOP12199 TOP12142 TOP12163

Herrmann AG

Bahnhofstrasse 32

D-93483 Pöding

Sales

Phone: +49 (0)9461/91388 50

Fax: +49 (0)9461/91388 55

E-Mail: sales@herrmann.de

Service

Phone: +49 (0)9461/91388 30

Fax: +49 (0)9461/91388 33

E-Mail: service@herrmann.de

www.herrmann.de